

CT-1, CY-1 (ST-1, SU-1)

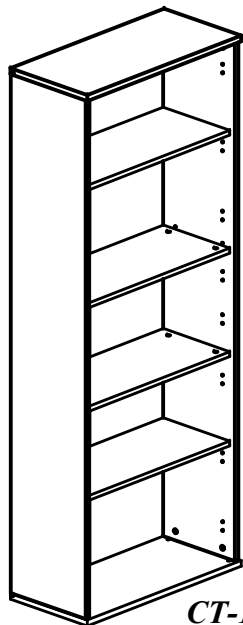

CT-1 (ST-1)

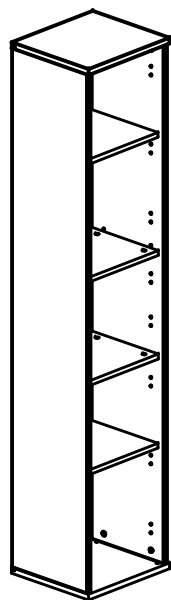



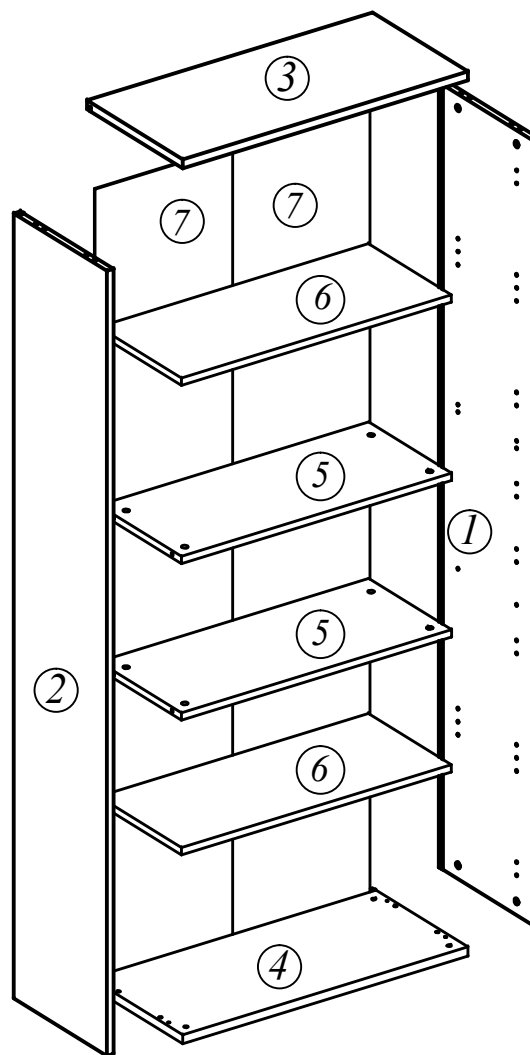

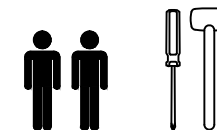

CY-1 (SU-1)

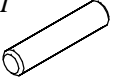

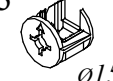
CT-1 (ST-1) - 770x365x1975
 CY-1 (SU-1) - 406x365x1975

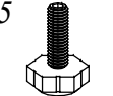
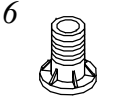
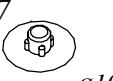

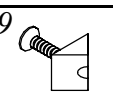
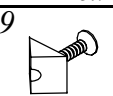
1		x8	2		x16
3		x16	4		x16
5		x4	6		x4
7		x4	8		x8
9		x8 (CY-1) (SU-1)	9		x10 (CT-1) (ST-1)

CT-1, CY-1 (ST-1, SU-1)

I

Diagram I shows the assembly of the front panel (1). It includes a list of parts: 1 (rod, x8), 2 (screw, x8), 3 (corner bracket, x8), and 8 (screw, x8). The diagram illustrates how these parts are used to secure the front panel to the side panels.

II

Diagram II shows the assembly of the side panels (3, 5) and the back panel (4). It includes a list of parts: 2 (screw, x8), 3 (corner bracket, x4), 5 (rod, x4), and 6 (rod, x4). The diagram illustrates how these parts are used to secure the side panels and the back panel to the front panel.

III

Diagram III shows the assembly of the side panels (2) and the back panel (1). It includes a list of parts: 3 (corner bracket, x8) and 5 (rod, x4). The diagram illustrates how these parts are used to secure the side panels and the back panel to the front panel.

IV

Diagram IV shows the assembly of the side panels (7) and the back panel (4). It includes a list of parts: 3 (corner bracket, x8). The diagram illustrates how these parts are used to secure the side panels and the back panel to the front panel.

V

Diagram V shows the assembly of the side panels (3) and the back panel (3). It includes a list of parts: 3 (corner bracket, x8). The diagram illustrates how these parts are used to secure the side panels and the back panel to the front panel.

VI

Diagram VI shows the assembly of the side panels (11) and the back panel (11). It includes a list of parts: 11 (corner bracket, x8 for CY-1/SU-1 and x10 for CT-1/ST-1). The diagram illustrates how these parts are used to secure the side panels and the back panel to the front panel.

VII

Diagram VII shows the final assembly of the side panels (6) and the back panel (7). It includes a list of parts: 4 (corner bracket, x16) and 7 (rod, x4). The diagram illustrates how these parts are used to secure the side panels and the back panel to the front panel.